

CREALITY

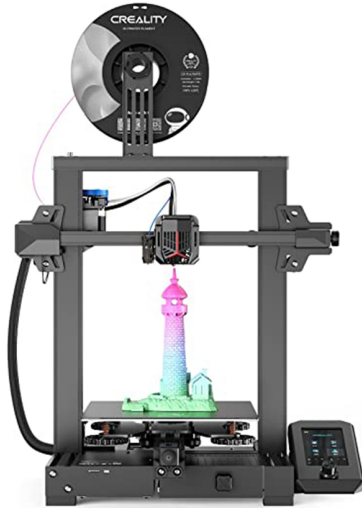

Creality Ender 3 V2 Neo 3D Printer

[Read More](#)

SKU: 3DWR1HE28T474

Price: 3,090.00 DH (HT)

Stock: instock

Categories: [FDM](#), [3D Printers](#)

Tags: [3d](#), [3d print](#), [3dprinter](#), [fmd](#)

Product Description

Super Deal | CREALITY

Event dates 19 December 2022 - 25 December 2022

First 30, platform subsidises BRL200

[Obtenha a compra imediatamente](#)



Creality Ender-3 V2 Neo 3D Printer, CR Touch Auto-leveling, Full-metal Bowden Extruder, Stable Integrated Design, 3-step Assembly, PC Spring Steel Magnetic Build Plate, Printing Size: 220*220*250mm

Ender-3 V2 Neo

Easy and Accurate Printing



CR Touch
Auto-leveling



Full-metal
Bowden Extruder



Stable Integrated
Design

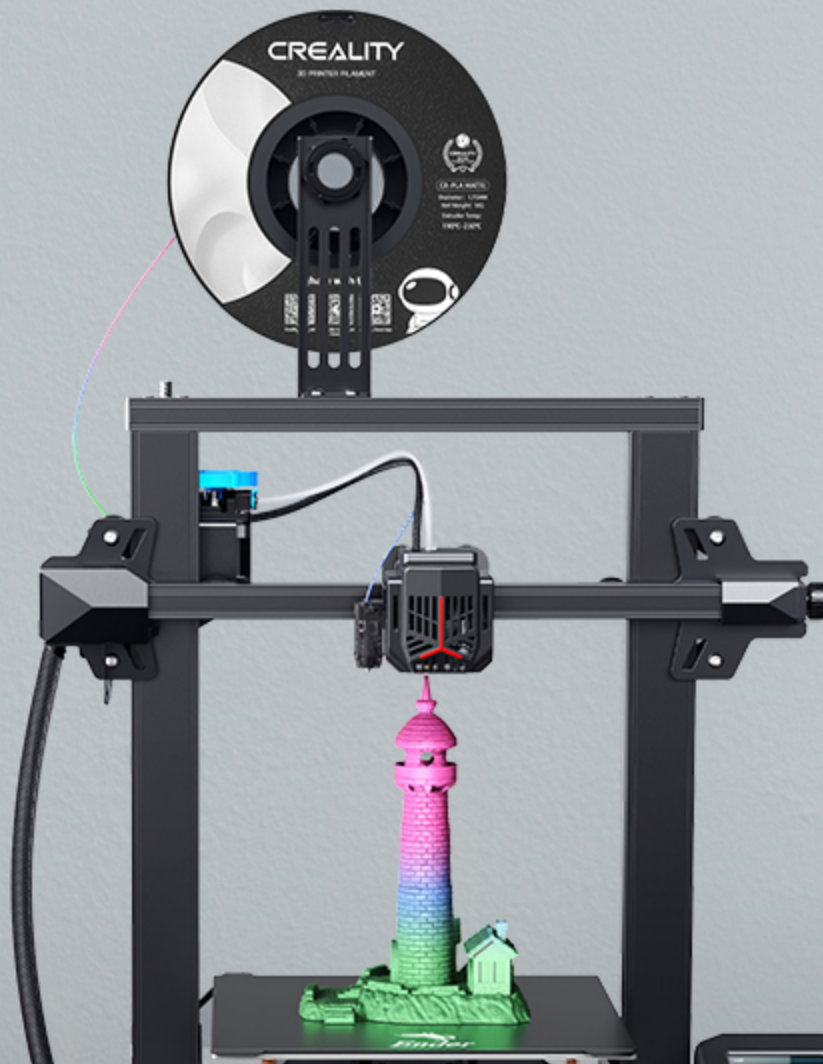



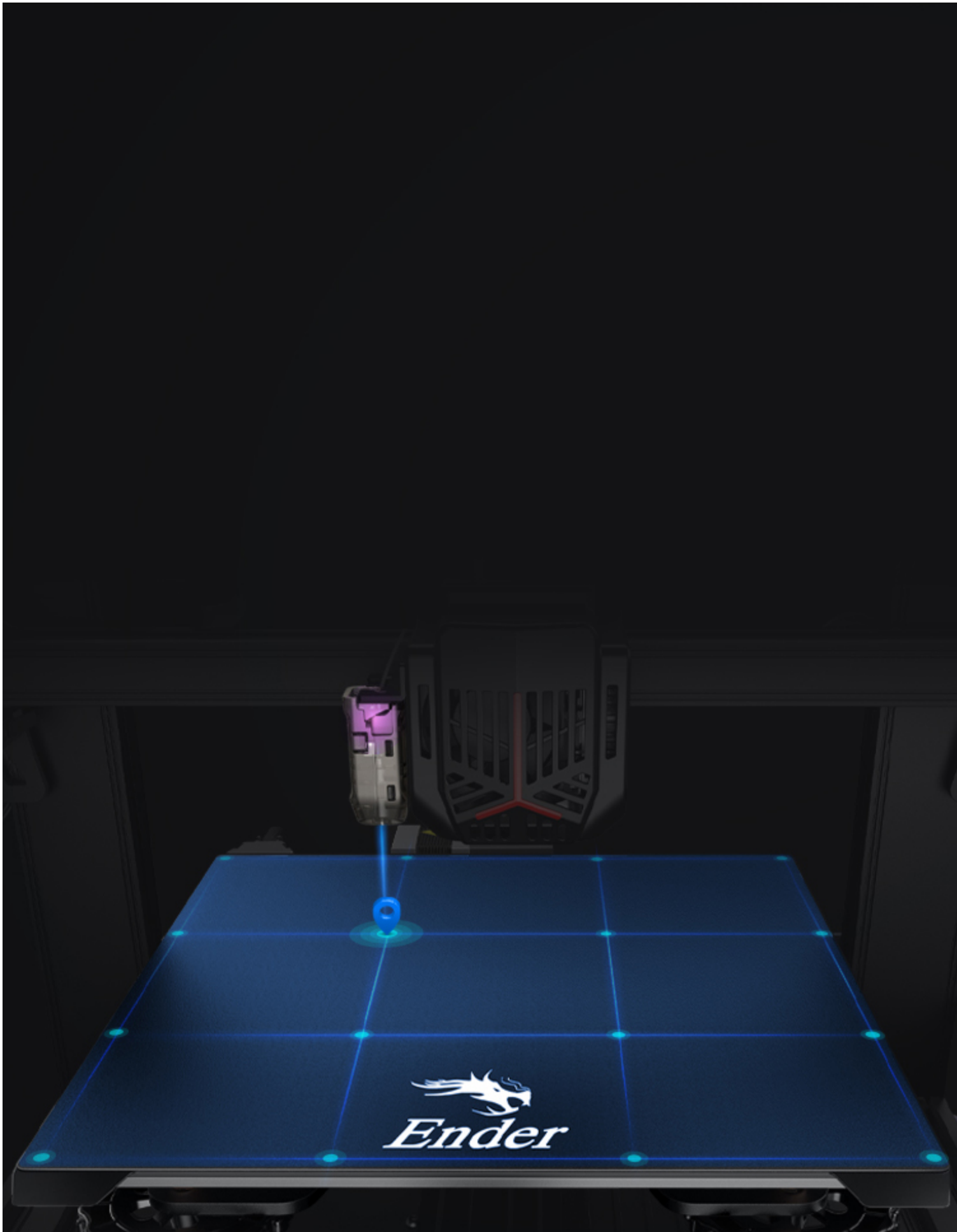

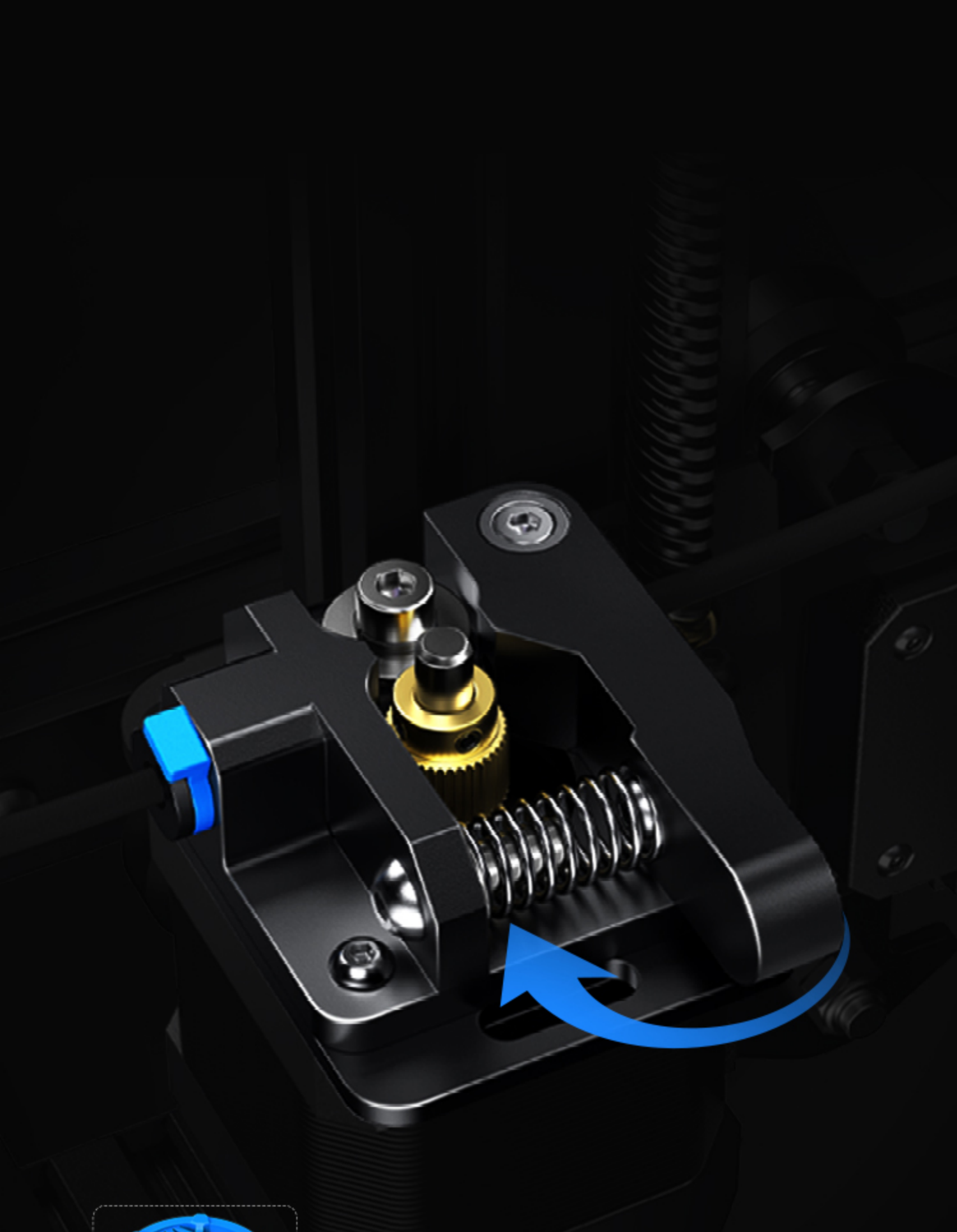

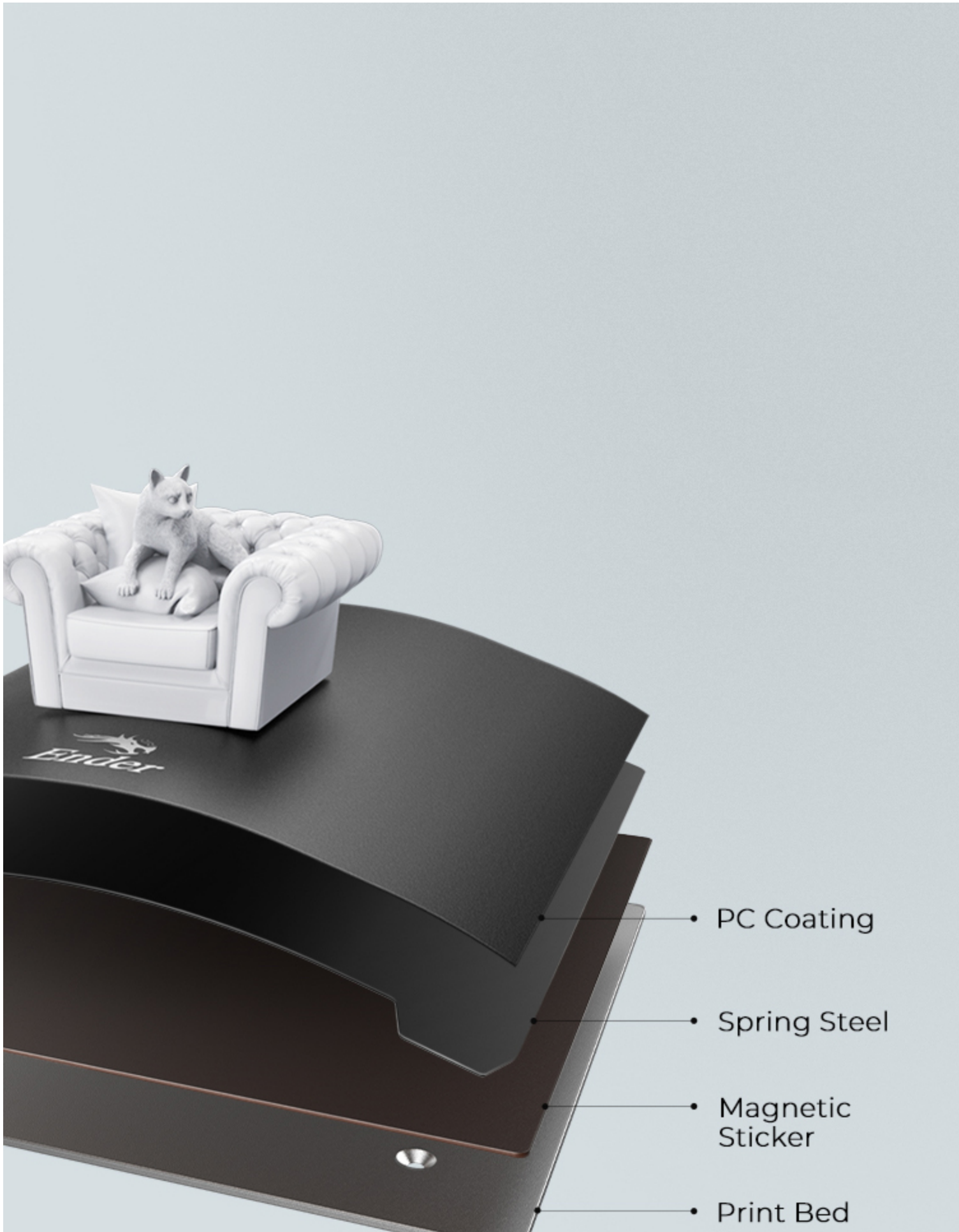

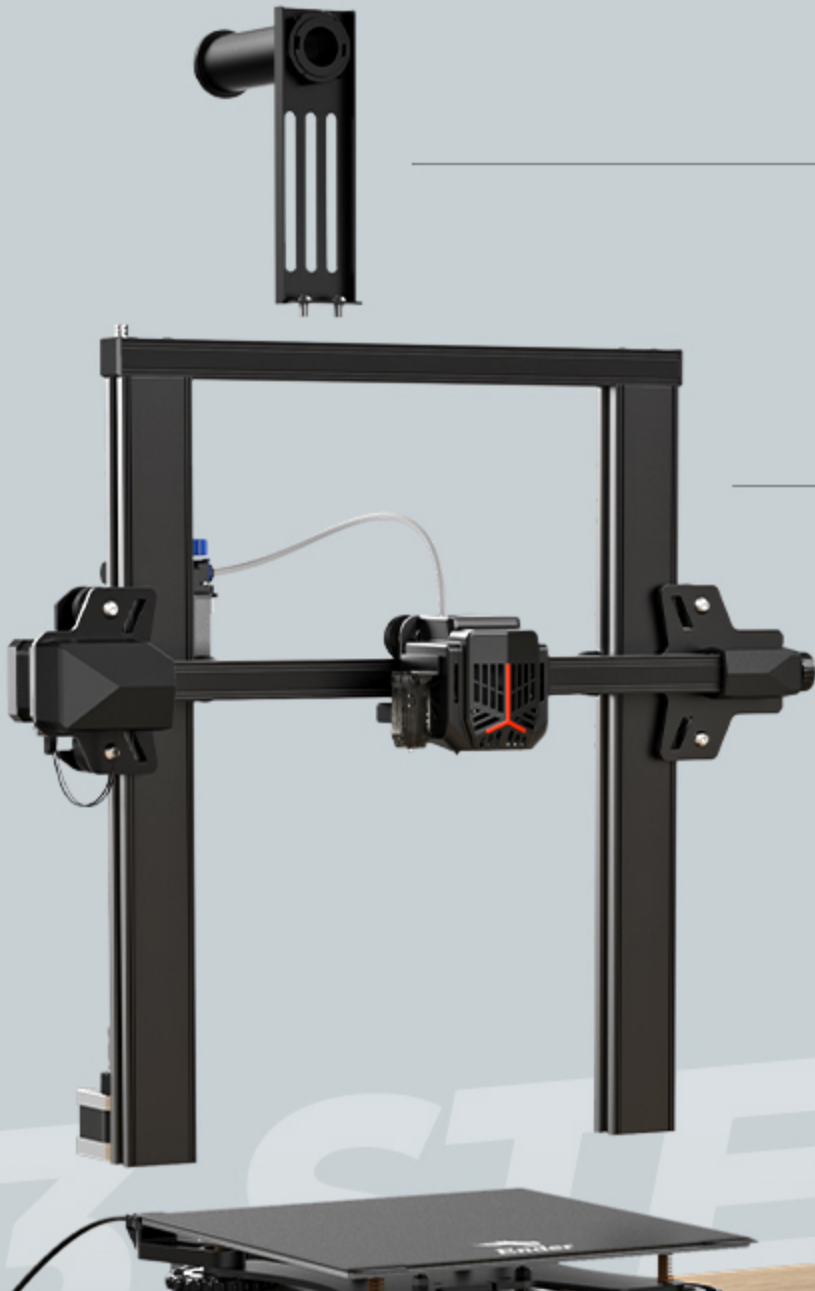

③ Install Rack

① Install Gantry

② Install Screen
(Buckle)

3 STEPS

Home

CREALITY

Print Prepare

Control Info

200/200 100% 255
60/60 100% ZI 0.00
149.2 120.9 0.0

Lighthouse



Estimated time: 0
Filament used: 0
Layer height: 0
Volume: 0

Confirm Cancel

200/200 100% 255
60/60 100% ZI 0.00
149.2 120.9 0.0

File selection

Back

Lighthouse

200/200 100% 255
60/60 100% ZI 0.00
149.2 120.9 0.0

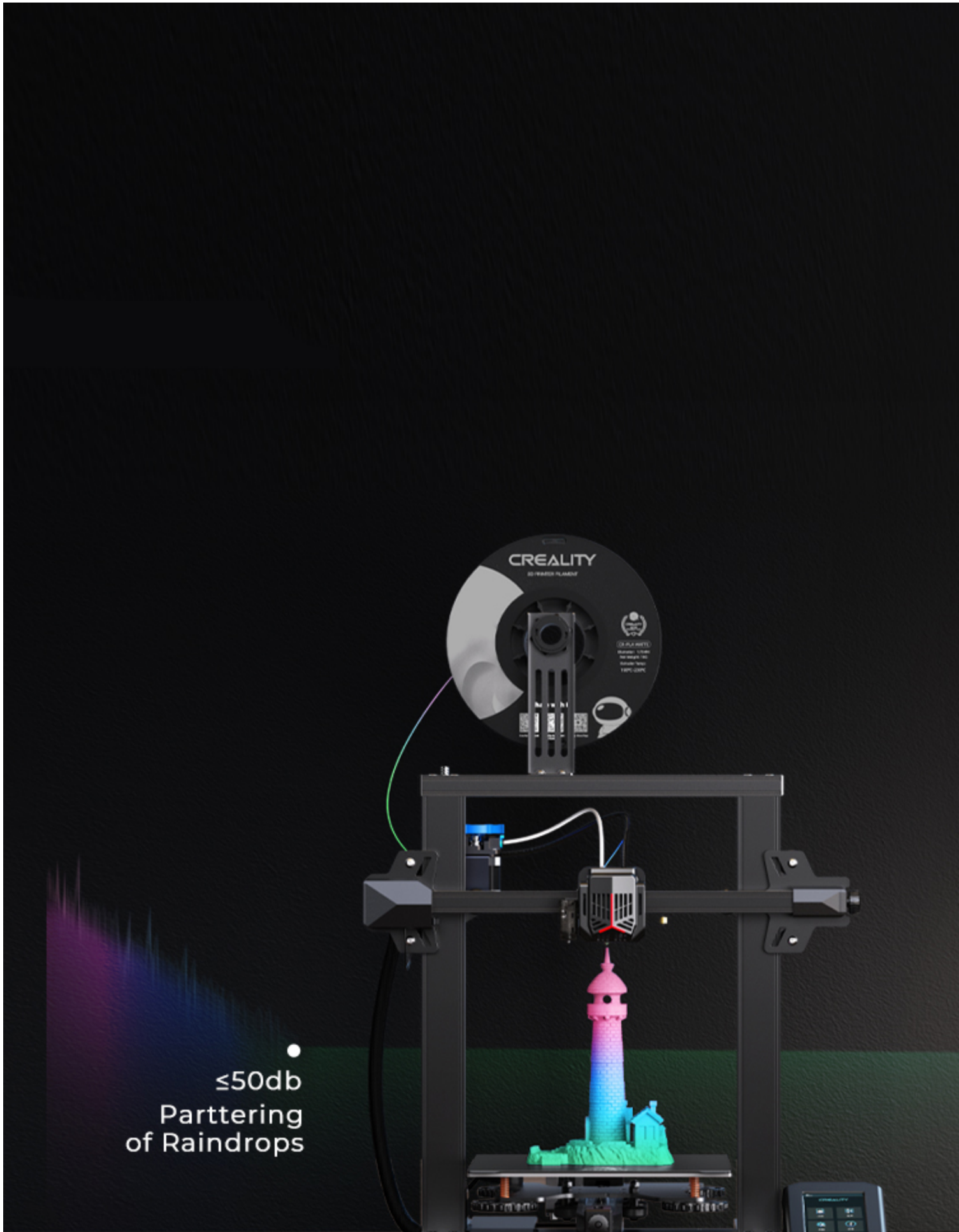

Human-centered Design



Built-in toolbox
- a perfect container for gadgets.



Product Parameters

Molding Technology: **FDM**

Build Volume: **220×220×250mm**

Machine Dimension: **438×424×472mm**

Package Dimension: **520×505×280mm**

Net Weight: **7.8kg**

Gross Weight: **9.8kg**

Printing Speed: **Maximum 120mm/s**

Printing Precision: **±0.1mm**

Layer Height: **0.1mm-0.4mm**

Filament Diameter: **1.75mm**

Nozzle Quantity: **1**

Nozzle Diameter: **0.4 mm (standard)**

Nozzle Temperature: **up to 260°C**

COMPANY INTRODUCTION

Shenzhen Creality 3D Technology Co., Ltd.

Creality 3D is an internationally renowned 3D printer manufacturer, national high-tech enterprise, and a pioneer in the R&D and mass production of FDM and resin 3D printers in China. Our company has been committed to applying 3D printers into market, delivering efficient and cost-effective integrated 3D printing solutions for individuals, families, schools and enterprises.

Headquartered in Shenzhen, Creality 3D has branches in Beijing, Shanghai and Wuhan, and cooperates with colleges and universities to build an industry-university-research teaching and internship base. We have a complete set of R&D, manufacturing and after-sales service system and strong technological strength. With a total area of 30,000m², a team of over 1,000 employees, and monthly production capacity of over 800,000 units, Creality 3D prides itself on its large-scale R&D center and 3D printing laboratories and Creality research institute. Coupled with modern production lines working for 24 hours nonstop and demanding quality control system, the excellent